

Kurzanleitung

Fahrzeugfunkgerät

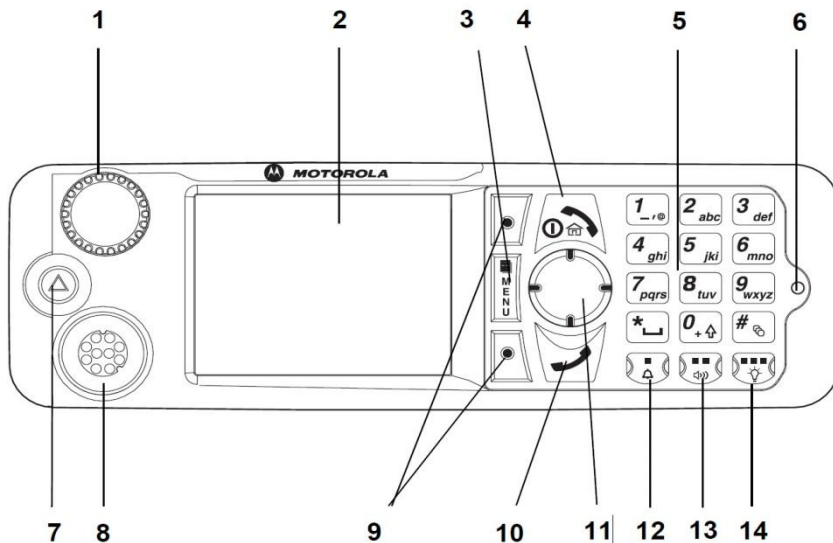



1. Drehknopf
2. Farbanzeige
3. Menütasten
4. Beenden-/Ausgangsmodus-Taste
5. Alphanumerische Tastatur
6. LED (Anzeige)
7. Notruftaste
8. Mobilmikrofonanschluss
9. Funktionstaste(n)
10. Sendetaste
11. Pfeiltaste
12. Gateway
13. TMO/DMO Modus
14. Beleuchtung

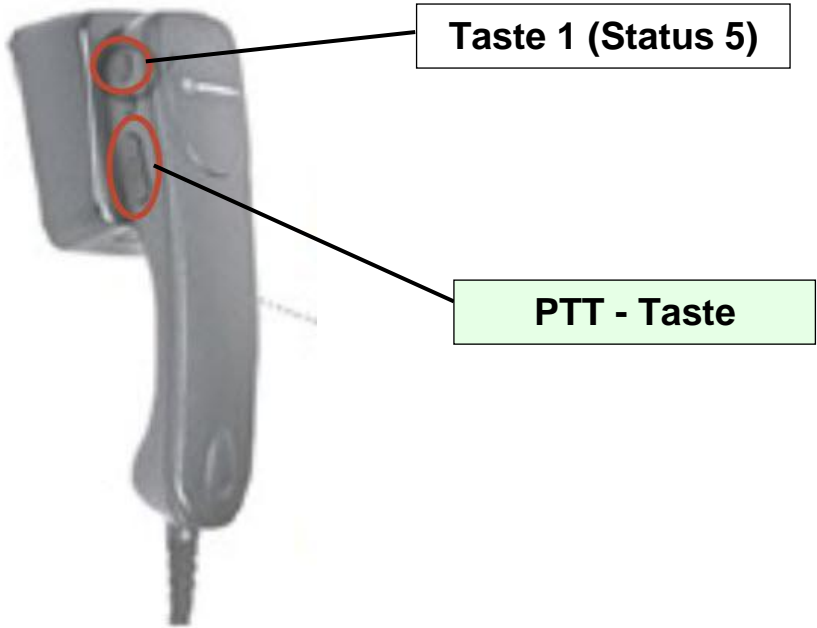

Ein/Ausschalten



***Das Gerät nur über den
Externen Schalter Ein bzw.
Ausschalten.***



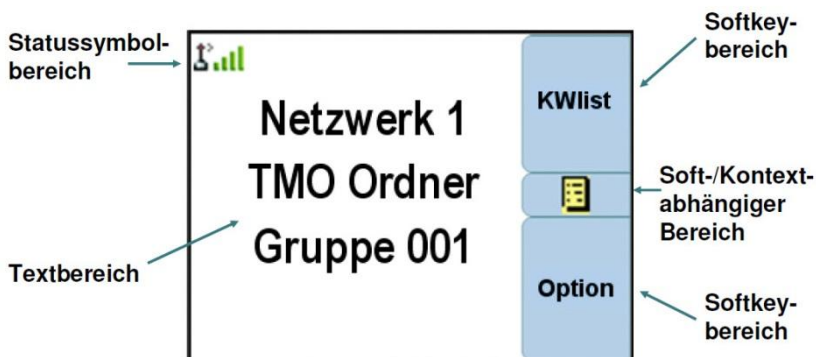











Display

















LED-Anzeige

LED	Beschreibung
Durchgehend grün	In Verwendung
Blinkt grün	In Betrieb
Durchgehend rot	Nicht in Betrieb/deaktiviert
Blinkt rot	Bei eingeschaltetem Gerät wird eine Verbindung mit einem Netz hergestellt/wird dieses einer Gruppe zugeordnet
Durchgehend orange	TXI in Betrieb
Blinkt orange	Eingehender Funkruf
Keine Anzeige	Ausgeschaltet



Symbol	Beschreibung
	Netz verfügbar (TMO)
	Kein Netz (TMO)
	Signalstärke
	Direkt-Modus (DMO)
	Gateway-Modus (DMO)
	Repeater-Modus (DMO)
	Notrufmodus
	Blättern durch Gesprächsgruppen
	Scan (TMO)
	Lautsprecher an
	Lautsprecher aus
	Alle Töne aus oder Duplex- und Simplexton stummgeschaltet
	Simplex-/Duplexton stummgeschaltet
	Hupe und Licht

Symbol	Beschreibung
	Einzelnes/duales Bedienteil
	Duales Bedienteil – Verbindungsfehler
	Tastendrucksymbol
	Neue Nachricht eingegangen
	Neue Nachricht(en)
	Paketdaten
	GPS
	WAP
	Ende-zu-Ende-Verschlüsselung
	RUI-Logon
	RUI-Paketdaten
	Vorfallmeldung
	RMS
	WAP-Box